

The auto-measurement of the gap of LCD glass plates using sub-pixel accuracy estimation

Chern-Sheng Lin^{a,*}, Jason Cho^a, Yun-Long Lay^b, Chia-Hau Lin^a, Nanjou Lin^a

^aDepartment of Automatic Control Engineering, Feng Chia University, Taichung, Taiwan, ROC

^bDepartment of Electronics Engineering, National Chin-Yi Institute of Technology, Taichung, Taiwan, ROC

Received 1 July 2004; received in revised form 15 October 2004; accepted 10 November 2005

Abstract

In this paper, the distance between laser spots has been measured using sub-pixel accuracy estimation and the accuracy has been tested in a noise environment. Here, the correlation like method (CLM) is used for the distance measurement between two laser spots and to count the estimation precision effect under noise factor by relevant CLM theorems. From the maximum value of the data series, then the position of the center of laser spot can be derived by interpolation. The estimation precision effect under noise factor and DC offset are tested and analyzed by a computer system. Also, for improving the estimation precision, a Kalman filter, which is often applied for random estimation and control theorem, is adopted. The innovation research combines CLM, and Kalman filter in sub-pixel accuracy estimation is more precise. This method can be used for measuring the gap of LCD glass plates, of optical strain gauge and the characteristics of spectral, quickly and can be automated.

© 2005 Elsevier GmbH. All rights reserved.

Keywords: Distance between laser spots; Correlation like method; Kalman filter

1. Introduction

An LCD assembly sequence consists of adhesive dispensing (required for sealing the panels), location and alignment of one plate with respect to the other and exposure to cure the adhesive and bond the two plates together [1]. In the assembly process, the distance between the top plate and bottom plate is from 0.06 to 0.1 mm. A rotator and an *xy*-table can drive the substrate to the correct position within a tolerance of 0.01–0.04 mm. There are many types of equipment used to measure the plate-to-plate distance accurately. This

paper focuses on the experimented system development for the measurement of the gap of LCD glass plates. The measurement system includes a laser light source, lens module, CCD image capturing system and the algorithm for calculation of the position of light spots. Generally, CCD sensors are used as opto-sensor for detecting the variation of the light intensity distribution. As shown in Fig. 1, the gap variation can be detected by the peak value of the distribution of reflected light intensity. The application of this system can also be used in the fields of optical strain gauge measurement [2] or spectral evaluation with optical grating.

The position of a single laser spot has been accurately measured by sub-pixel estimation method for a long time in different application fields. Lots of relevant methods for detecting the laser spot position have been

*Corresponding author. Tel.: +886 4 4517250x3929; fax: +886 4 4519951.

E-mail address: cslin@auto.fcu.edu.tw (C.-S. Lin).

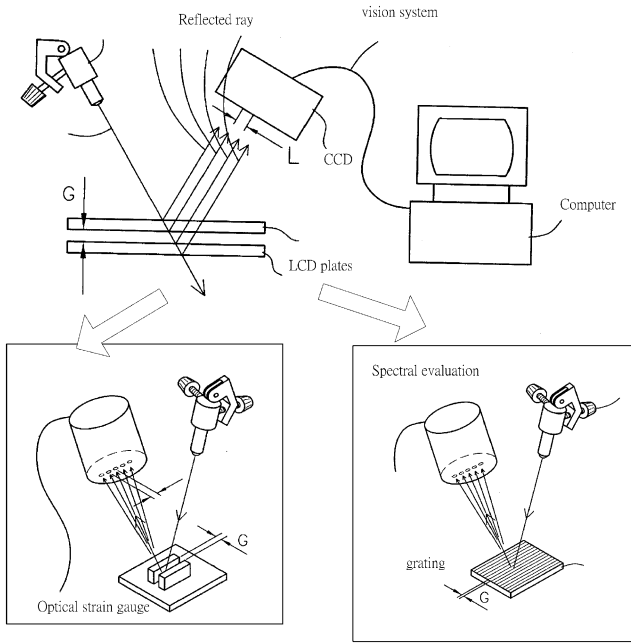

Fig. 1. Multipurpose measurement application in the fields of the gap measuring of LCD glass plates, optical strain gauge and spectral evaluation with optical grating.

proposed and discussed recently. Owing to the high-quality demand of manufactures, the distance measurement between two laser spots is important and more and more necessary. For the digital image processing and analysis, the position measurement of a laser spot can be done by sub-pixel centroid calculation method (CCM), Fourier phase shift method (FPS) or correlation like method (CLM).

Each method has their defects. For the CCM method, an error item will be occurred in the calculation process and the estimation precision will be easily affected by noise [3].

For the FPS method [4,5], the estimation precision is not much affected by noise or DC offset, but the phase analysis is more complicate.

As the CLM method [6,7], the sample pattern or the laser spot model should be created in advance using interpolation method for higher the estimation precision of the sub-pixel [8,9].

In order to calculate the laser spots distance, this paper extended the CLM for the distance measurement between two laser spots and to count the estimation precision effect under noise factor by relevant CLM theorems. Also, the estimation precision effect under noise factor and DC offset are tested and analyzed by a computer system.

Finally, to increase the estimation precision, a Kalman filter for random estimation and control theorem is applied. The effect by the Kalman filter is also tested by a computer to know the improvement degree of the measurement precision while using the filter.

2. Theorem analysis

2.1. Correlation like method

$u(x)$ and $f(x)$ are the light intensity distribution functions of two laser spots, as shown in Fig. 2(A). Their correlation function could be derived as

$$r(x) = \lim_{T \rightarrow \infty} \frac{1}{T} \int_{-T/2}^{T/2} u(\tau)f(\tau - x) d\tau. \quad (1)$$

Assume both $f(x)$ and $u_0(x)$ are even functions. This means $f(\xi) = f(-\xi)$, $u_0(\xi) = u_0(-\xi)$ and $u(x) = u_0(x - \bar{x}_c)$; then the light intensity functions of two laser spots $f(x)$ and $u(x)$ can be further derived as follows:

$$\begin{aligned} r(x) &= \lim_{T \rightarrow \infty} \frac{1}{T} \int_{-T/2}^{T/2} u(\tau)f(\tau - x) d\tau \\ &= \lim_{T \rightarrow \infty} \frac{1}{T} \int_{-T/2}^{T/2} \{U_0(s)F(s)\} \exp(i2\pi s(x - \bar{x}_c)) ds. \end{aligned} \quad (2)$$

From Eq. (2), the maximum value of function $r(x)$ is at $x = \bar{x}_c$.

The correlation function after digital sampling can be represented as

$$r_i = \sum_j u_j f_{j-i}. \quad (3)$$

Assume $r(i)$ is the maximum value of the series of Eq. (3), as shown in Fig. 2(B), then the position of the center of laser spot \bar{x}_c can be derived by interpolation [8]. That is

$$x_c = \frac{r(i-1) - r(i+1)}{2[r(i-1) + r(i+1) - 2r(i)]}. \quad (4)$$

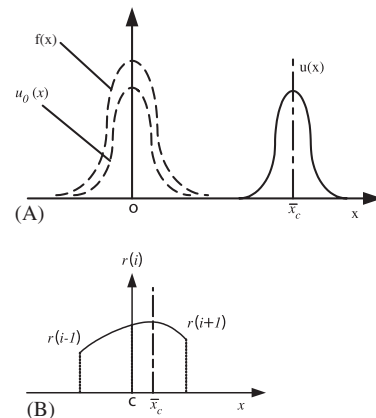

Fig. 2. (A) Light intensity distribution functions of two laser spots. (B) Position of the center of laser spot can be derived from the maximum value and the neighbors of the series.

2.2. Effect of noise

2.2.1. Effect of DC offset

Assume a DC bias occurs from the sensor called a . The light intensity of these two laser spots can be represented as

$$u_a(x) = u(x) + a, \quad (5)$$

$$f_a(x) = f(x) + a. \quad (6)$$

The correlation functions of these two intensity distribution functions $u_a(x)$ and $f_a(x)$ can be derived as follows:

$$\begin{aligned} r_a(x) &= \lim_{T \rightarrow \infty} \frac{1}{T} \int_{-T/2}^{T/2} u_a(\tau) f_a(\tau - x) d\tau \\ &= \lim_{T \rightarrow \infty} \frac{1}{T} \int_{-T/2}^{T/2} [u(\tau) + a][f(\tau - x) + a] d\tau \\ &= \lim_{T \rightarrow \infty} \frac{1}{T} \left\{ \int_{-T/2}^{T/2} \{[u(\tau)f(\tau - x)]\} d\tau \right. \\ &\quad \left. + \int_{-T/2}^{T/2} \{[u(\tau)a] + [f(\tau - x)a] + a^2\} d\tau \right\}. \quad (7) \end{aligned}$$

The last term of Eq. (7) is nothing to do with the maximum position of $r_a(x)$, this means the maximum value of $r_a(x)$ is still at the position \bar{x}_c . Hence, the DC offset will not affect the measurement precision by using the CLM.

2.2.2. Effect of high frequency noise

Assume a high frequency noise occurs from the sensor called $n(x)$. The light intensity of these two laser spots can be represented as

$$u_n(x) = u(x) + n(x), \quad (8)$$

$$f_n(x) = f(x) + n(x). \quad (9)$$

The correlation functions of these two intensity distribution function $u_n(x)$ and $f_n(x)$ can be derived as follows:

$$\begin{aligned} r_n(x) &= \lim_{T \rightarrow \infty} \frac{1}{T} \int_{-T/2}^{T/2} u_n(\tau) f_n(\tau - x) d\tau \\ &= \lim_{T \rightarrow \infty} \frac{1}{T} \int_{-T/2}^{T/2} \{[u(\tau)f(\tau - x)]\} d\tau \\ &\quad + \lim_{T \rightarrow \infty} \frac{1}{T} \int_{-T/2}^{T/2} \{[u(\tau)n(\tau - x)] \\ &\quad + [f(\tau - x)n(\tau)] + [n(\tau)n(\tau - x)]\} d\tau. \quad (10) \end{aligned}$$

Assume $n(x)$ is a typical type of the random noise, then the integration of the last term of Eq. (10) is zero. Hence, the maximum value of $r_n(x)$ is still at the position \bar{x}_c . In practice, the position calculating must be

estimated and quantized by suitable filter to allow for possible noise disturbance in the image data [10].

2.3. Kalman filter

If the standard deviation $\sigma_1\sigma_2$ and the median x_1x_2 are obtained from two kinds of estimation method with the Gaussian distribution, then the optimum gain of the Kalman filter can be shown as equation (11).

$$K = \frac{\sigma_1^2}{\sigma_1^2 + \sigma_2^2}. \quad (11)$$

The optimum estimation value should be

$$x_{\text{opt}} = x_1 + K(x_2 - x_1). \quad (12)$$

The estimation standard deviation of the Kalman filter output is as follows:

$$\sigma = \sqrt{\frac{\sigma_1^2\sigma_2^2}{\sigma_1^2 + \sigma_2^2}}. \quad (13)$$

Kalman filter can provide effective noise cancellation by using the same derivation steps measure N times by a single estimation method. Assume, the standard deviation of the estimation is σ_s , then the optimum estimation value can be calculated by a recursive operation shown as follows:

$$x_{\text{opt}2} = x_1 + K_1(x_2 - x_1), \quad (14)$$

where $K_1 = 1/2$,

$$x_{\text{opt}3} = x_{\text{opt}2} + K_2(x_3 - x_{\text{opt}2}), \quad (15)$$

where

$$K_2 = \frac{\sigma_s^2}{\sigma_s^2 + \sigma_{\text{opt}2}^2},$$

$$x_{\text{opt}(N)} = x_{\text{opt}(N-1)} + K_{N-1}(x_N - x_{\text{opt}(N-1)}), \quad (16)$$

where

$$K_{N-1} = \frac{\sigma_s^2}{\sigma_s^2 + \sigma_{\text{opt}(N-1)}^2},$$

where $x_{\text{opt}(N)}$ is the optimum estimation value. The estimation standard deviation of the Kalman filter output is

$$\sigma_N = \frac{\sigma_s}{\sqrt{N}}. \quad (17)$$

3. Experimental results

3.1. Relative parameters of the simulation

In order to simulate the estimation algorithm for the position of two laser spots mentioned above, the laser spot profile has been assumed as a Gaussian

distribution. The mathematical expression can be represented as

$$u = u_0 \exp\left(\frac{-2r^2}{w^2}\right), \tag{18}$$

where w is the line width.

Two kinds of background noise have been discussed at the simulation stage in order to know the noise effect:

- (1) *Gaussian white noise*: The probability density function of the Gaussian white noise can be represented as

$$f(x) = \frac{1}{s\sqrt{2\pi}} \exp\left(-\frac{x^2}{2s^2}\right), \tag{19}$$

where s is the standard deviation.

- (2) *DC offset*: This is the DC bias of the testing image signal.

3.2. Simulation of linearity deviation

In order to find the linearity deviation of the estimation distance between two laser spots, the simulation conditions are set in Table 1. The simulation steps are shown in Fig. 3. The left laser spot was set fixed. The right laser spot moved 99 times by 0.1 pixels each time. The distance change between the two laser spots has been measured for each movement of the right laser spot.

The results of the simulation are shown in the following figures.

The linearity deviation curve of the laser spot density profile under the first condition of the simulation is shown in Fig. 3. This system consists of a precise translation stage to change the gap of LCD plates, and one set of laser source and CCD camera to scan the variation of reflected pattern. The camera is connected to the frame grabber. The linearity deviation curve of the CLM estimation results under the first condition of the simulation is shown in Fig. 4. The error curve to show the difference between the CLM estimation and the experiment results under the first condition of the simulation is shown in Fig. 5.

3.3. Repeatability precision simulation

The condition for the repeatability precision simulation is shown in Table 2. The simulation method is to set

the left-side laser spots to be fixed, and then to estimate the distance between two laser spots continuously for 100 times to find the maximum difference. The results of the repeatability precision simulation are shown as follows.

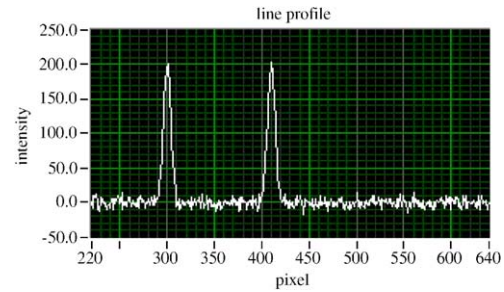

Fig. 3. Linearity deviation curve of the laser spot density profile under the first condition of the simulation.

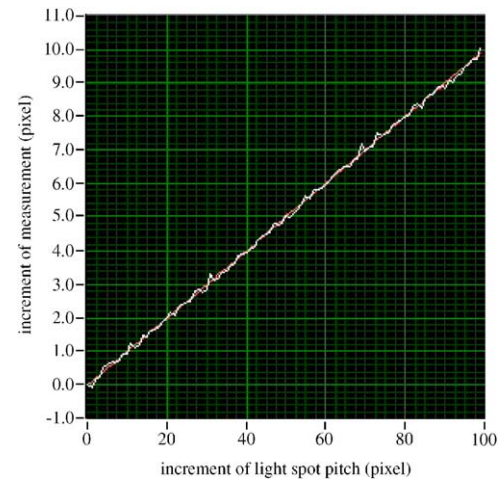

Fig. 4. Linearity deviation curve of the CLM estimation results under the first condition of the simulation.

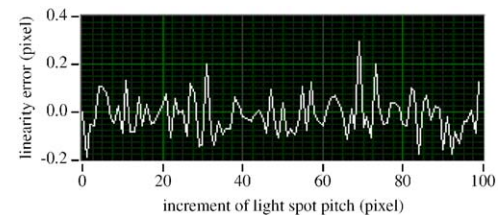

Fig. 5. Error difference between the CLM estimation and the experiment results under the first condition of the simulation.

Table 1. Simulation conditions of the system

Condition	Parameter		
	Profile and maximum amplitude	Gaussian white noise	DC noise
1	Gaussian distribution $u_0 = 200$	$s = 5.76$	DC = 0
2	Gaussian distribution $u_0 = 200$	$s = 5.76$	DC = 11.18

The real error curve was measured by the result of CLM estimation using the repeatability precision simulation, as shown in Fig. 6. The simulation results for the repeatability precision simulation under different conditions are shown in Table 3.

Table 2. Simulation results of the linearity deviation (unit: pixel)

Condition	Maximum linearity deviation	Minimum linearity deviation
1	0.292	-0.19
2	0.288	-0.195

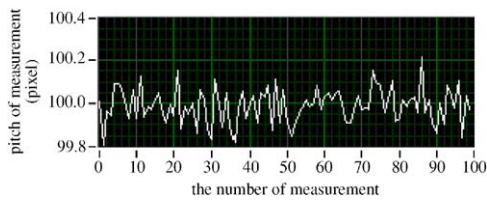

Fig. 6. Real error curve measured by the result of CLM estimation using the repeatability precision simulation.

Table 3. Simulation results for the repeatability precision simulation (unit: pixel)

Condition	Repeatability precision
1	0.408
2	0.386

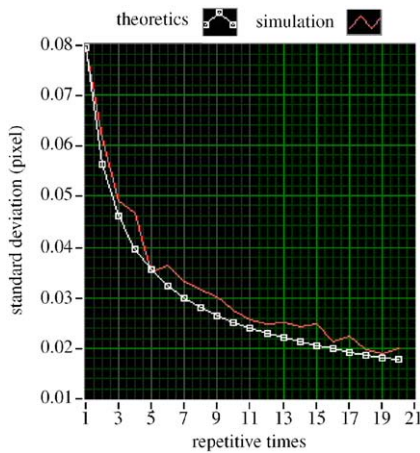

Fig. 7. Comparing chart of the real and theoretical curve measured by the CLM with Kalman filter.

3.4. Improvement of the estimation precision, using Kalman filter

The estimation precision has been improved for detecting the distance between two light laser spots by using Kalman filter and the simulation conditions are set as in Table 1 condition 2. Also, the recursive times for the simulation are set from 1 to 20. The simulation results are shown in the following figures.

The comparing chart of the real and theoretical curve was measured by the CLM with Kalman filter to improve the estimation result, as shown in Fig. 7.

The real error curve was measured by the CLM with Kalman filter to improve the repeatability precision simulation, as shown in Fig. 8.

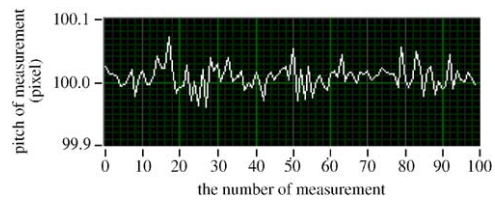

Fig. 8. Real error curve measured by the CLM with Kalman filter.

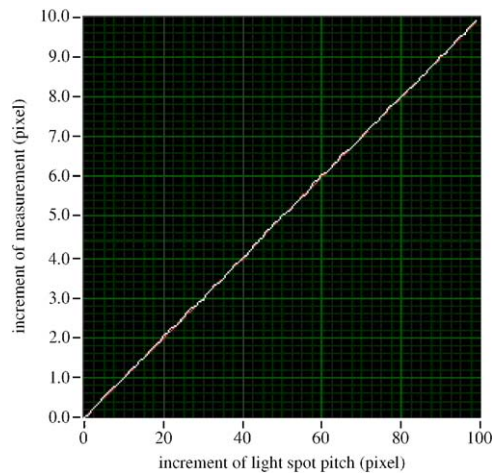

Fig. 9. Testing result measured by the CLM with Kalman filter to improve the linearity deviation.

Table 4. Simulation results for improvement of the estimation precision by Kalman filter (unit: pixel)

Item	Estimation precision improvement
Repeatability precision	0.111
Maximum linearity deviation	0.069
Minimum linearity deviation	-0.047

Table 5. Comparison of the measurement results (unit: pixel)

Result	Method			
	Centroid calculation		CLM with Kalman filter	
	Maximum linearity deviation	Minimum linearity deviation	Maximum linearity deviation	Minimum linearity deviation
1. Incident angle = 30°				
2. Background deviation = 0				
3. DC offset = 1	1.219	−0.321	0.057	−0.076

The testing result was measured by the CLM with Kalman filter to improve the linearity deviation, as shown in Fig. 9. Using Kalman filter to improve the measurement precision of the distance of two laser spots is shown in Table 4. After comparing Table 1, Table 4 and Figs. 7–9, it is shown that the Kalman filter is a good approach to improve the measurement precision for getting the better deviation, repeatability precision and linearity deviation precision. Experiments were conducted that illustrate the comparisons between this system and a typical CCM (Table 5).

4. Conclusion

In this paper, the distance between two laser spots has been measured using Correlation Like Algorithm estimation, and the accuracy has been analysed by relevant theorems. In order to understand the performance of the Correlation Like Algorithm under the noise environment, the analysis has been done in the DC noise and high frequency noise environment.

The simulation results show that the Correlation Like Algorithm possesses as very good noise-depression ability. The distance measurement algorithm of two Gaussian distribution laser spots has been tested by software system. The estimation precision of the Correlation Like Algorithm has been improved by using Kalman filter under noise environment. The combination of CLM and Kalman filter in sub-pixel accuracy estimation is a new method. This system with accuracy of 0.1 pixel can be used in measuring the gap of LCD glass plates, optical strain gauge and the characteristics of spectral. The multipurpose measurement application with unsophisticated and economical equipment is confirmed in LCD assembly manufacturing process.

Acknowledgment

This work was sponsored by the National Science Council, under grant number NSC92-2212-E-035-006.

References

- [1] C.S. Lin, Y.L. Lay, C.C. Huan, H.C. Chang, T.S. Hwang, An image-based LCD positioning system utilizing the modified FHT method, *Optik* 114 (4) (2003) 151–160.
- [2] C.S. Lin, Y.L. Lay, C.W. Ho, A.C.Y. Lin, N.C. Chang, A novel experimental device with modified laser shadow spot and optical strain gauge set-up, *Measurement* 37 (1) (2005) 9–19.
- [3] B.F. Alexander, K.C. Ng, Elimination of systematic error in sub-pixel accuracy centroid estimation, *Opt. Eng.* 30 (1991) 1320–1331.
- [4] J.P. Fillard, Subpixel accuracy location estimation from digital signals, *Opt. Eng.* 31 (1992) 2465–2471.
- [5] J.P. Fillard, H. M'timet, J.M. Lussert, M. Castangne, Computer simulation of super-resolution point source image detection, *Opt. Eng.* 31 (1992) 2465–2471.
- [6] S. Bosco, M. Trivi, Correlation like algorithm for superresolution analysis, *Opt. Commun.* 115 (1995) 444–448.
- [7] F.M. Dickey, L.A. Romero, Normalized correlation for pattern recognition, *Opt. Lett.* 16 (15) (1991) 1186–1188.
- [8] S.B. Colegrove, B. Cheung, A peak detector that picks more than peaks, *IEEE Radar* (2002) 15–17.
- [9] J. Cho, C.S. Lin, B.J. Jan, C.H. Lin, N.C. Chang, An opto-electrical method for measuring the gap of LCD glass plates, *Opt. Laser Technol.* 37 (8) (2005) 623–630.
- [10] C.S. Lin, C.Y. Wu, H.C. Hsu, K.M.C. Li, L. Lin, Rapid bio-test strips reader with image processing technology, *Optik* 115 (8) (2004) 363–369.